

BUSTER + PUNCH

LONDON

[product.]

L - BAR

[type. **HARDWARE.**]

[knurl. **LINEAR.**]

[detail. **TORX SCREW.**]

An L-bar made from solid metal and featuring our signature, diamond-cut, linear knurl pattern. Finished with a precision milled base, backplate and torx screw detailing.

[finish. **STEEL.**]



[finish. **BRASS.**]



[finish. **GUN METAL.**]



[finish. **BLACK.**]



[finish. **BURNT STEEL.**]

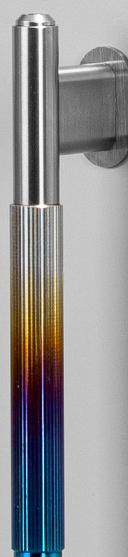

[type. **HARDWARE.**]

[info. **MEASUREMENTS.**]

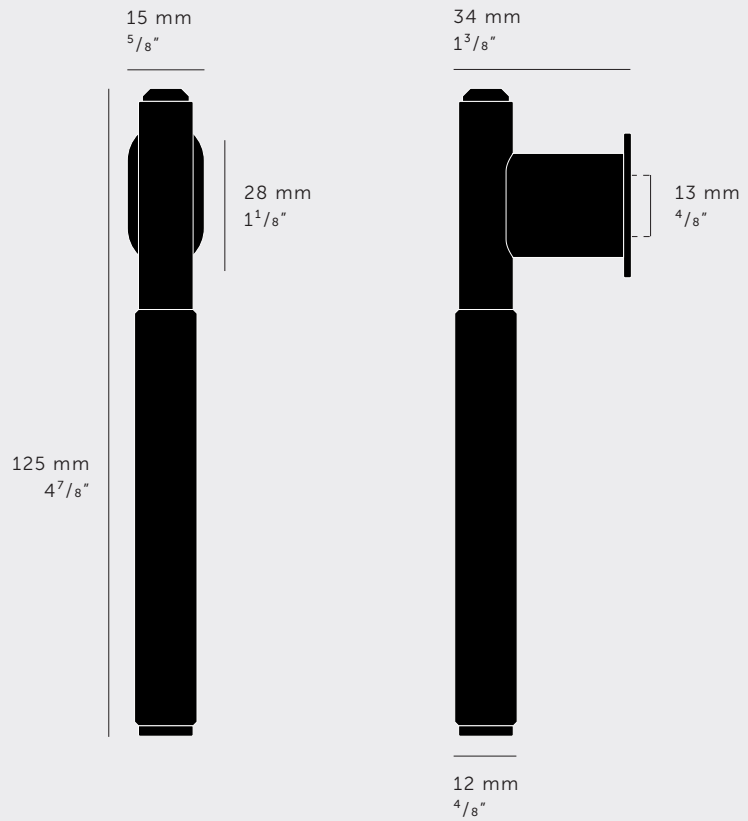

[info. **SPECIFICATIONS.**]

1 solid metal l-bar

Rear fixing

Fits doors of:

Max 18mm or 45/64**





*For thicker doors you will need to source longer M6 screws

[info. **FINISH & SKU NUMBERS.**]

[finish.]

[UK.]

[US.]

 Steel	GLB-07325	NLB-07370
 Burnt Steel	GLB-36440	NLB-36450
 Brass	GLB-05326	NLB-05371
 Gun Metal	GLB-35329	NLB-35373
 Black	GLB-02328	NLB-02374

[info. **CARE INSTRUCTIONS.**]

Wipe with damp cloth with no loose hairs, avoid using any chemicals.
Please note all finishes are prone to aging.

[info. **ALSO INCLUDED.**]

1x Oval washer

2x M6 x 25 mm screws



1 pcs

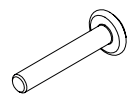

2 pcs